

# CLIFF SWITCHES

## 4066 SERIES

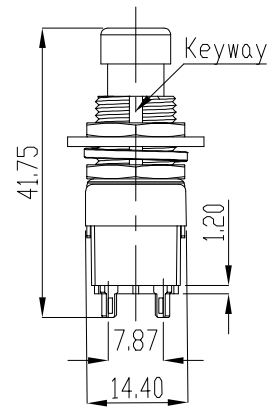

- FC7105** - DPDT Momentary solder tags.
- FC71055** - DPDT ON/OFF solder tags.
- FC7106** - DPDT Momentary PC tags.
- FC71065** - DPDT ON/OFF PC tags

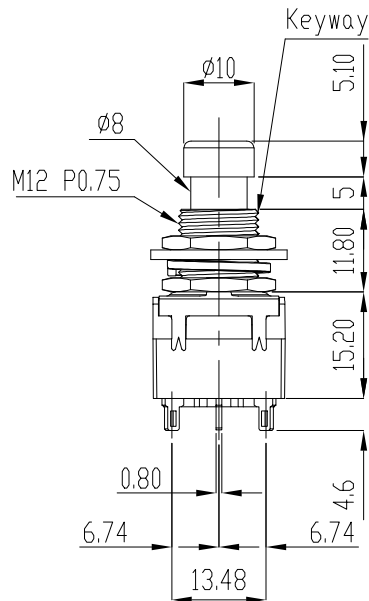
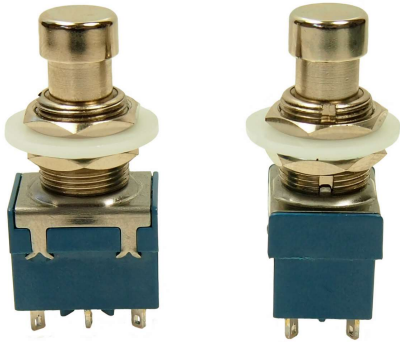
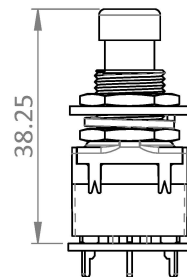
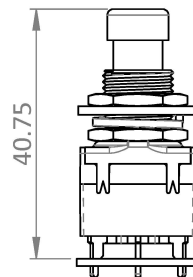
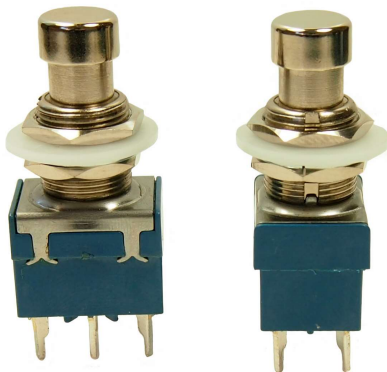
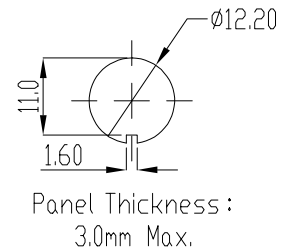
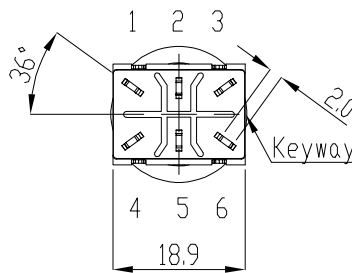

### Specification

- Rating: AC125V 4A, 250V 2A.
- Contact Resistance: 50mΩ max.
- Insulation Resistance: DC500V 100MΩ min.
- Dielectric Strength: AC1500V 1 minute.
- Operating temp: -20°C to +65°C
- Electrical life: 50,000 make/break cycles at full load.

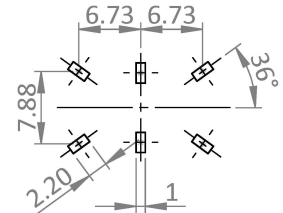
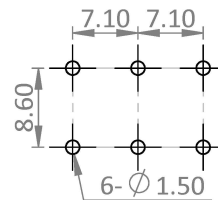

# CLIFF SWITCHES

## 3 POLE SERIES

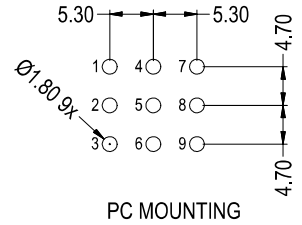
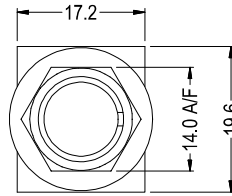
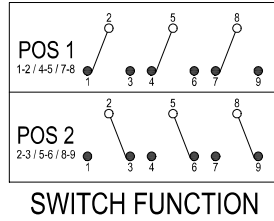
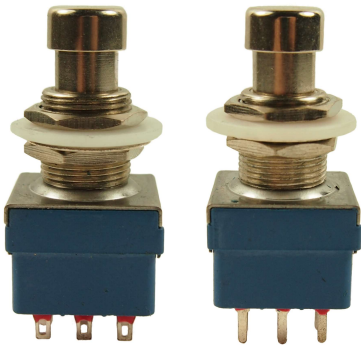

**FC71101** - 3PDT switch solder tags ON/OFF

**FC71102** - 3PDT switch PCB tags ON/OFF

### Specification

Rating: AC125V 4A, 250V 2A.

Contact Resistance: 20mΩ max.

Insulation Resistance: DC500V 100MΩ min.

Dielectric Strength: AC1500V 1 minute.

Operating temp: -20°C to +65°C

Electrical life: 20,000 make/break cycles at full load.

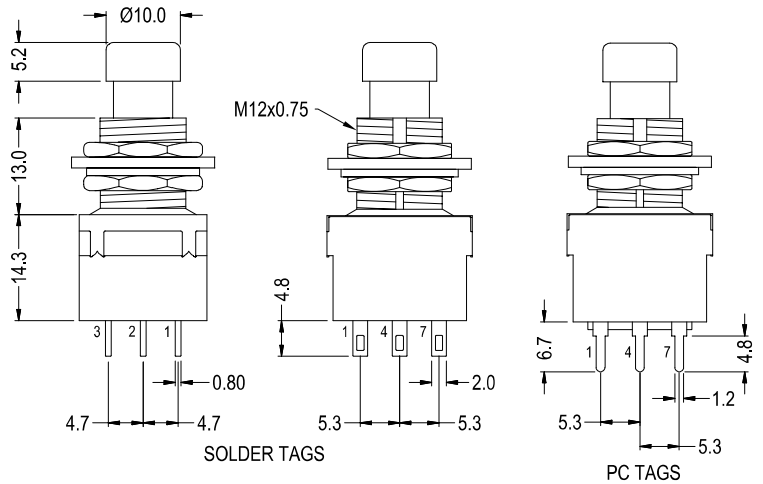

## FOOTSWITCH SPRING ACTUATOR



Part No. **FC7125**

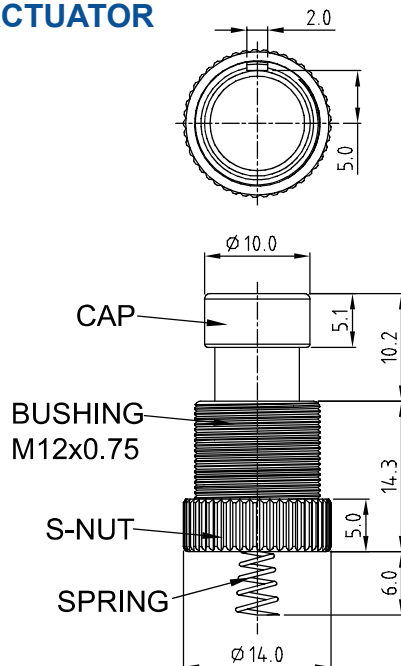

Operating Force: 650±250gf

Life Cycles: 20,000 times

Supplied with 1 nut and 1 washer

For further information, contact [sales@cliffuk.co.uk](mailto:sales@cliffuk.co.uk)

**Cliff Electronic Components Limited,**  
76 Holmethorpe Avenue, Holmethorpe Ind. Estate,  
Redhill, Surrey RH1 2PF U.K.  
Tel: +44 (0)1737 771375 Fax: +44 (0)1737 766012

[www.cliffuk.co.uk](http://www.cliffuk.co.uk)

