

CLIFF

LC OM3 DUPLEX METAL FEEDTHROUGH CONNECTOR

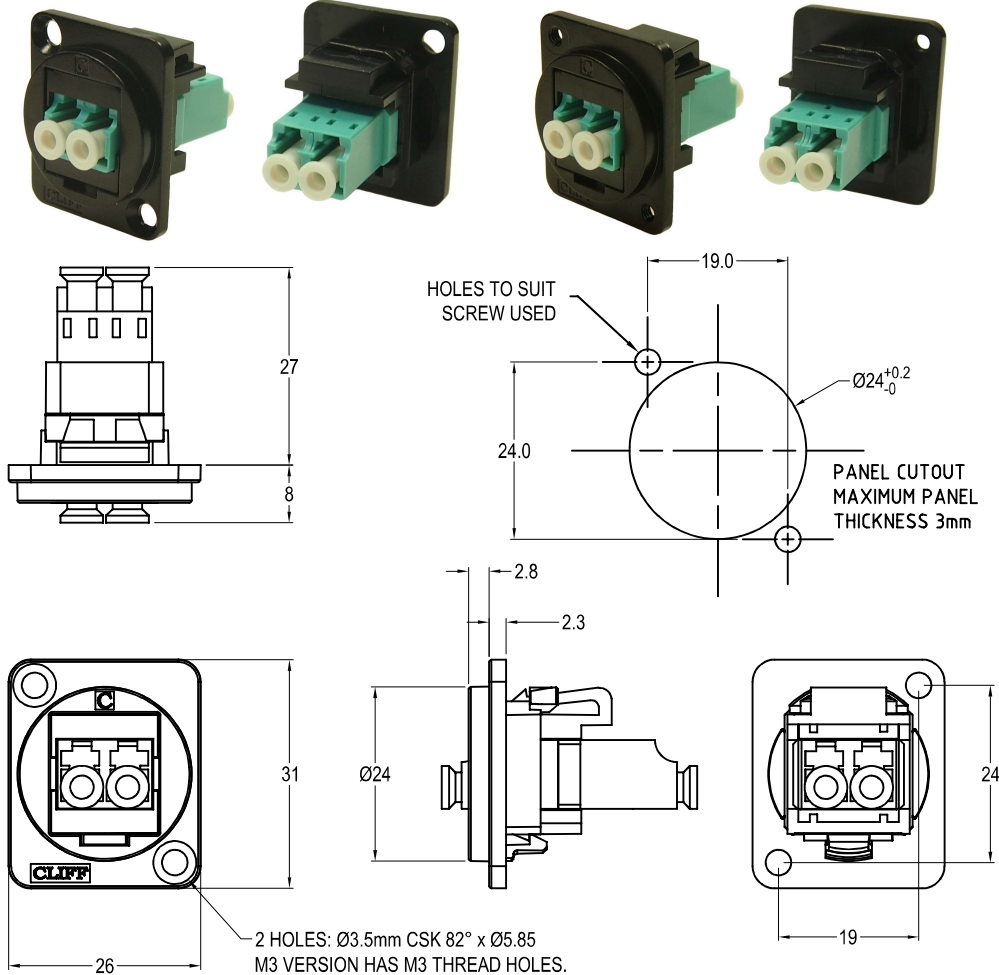

Feedthrough Features

- Fits standard XLR Ø24mm cutout.
- No soldering or punch termination. Use standard cable for each connector style.
- Front or rear mounted.
- Low rear profile

General:

Please note: Functionality is affected by cable quality, length and cable wiring configuration.

VARIANTS

Part No.

- CP30246MB** LC OM3 Duplex Black metal frame, CSK holes
CP30246M3B LC OM3 Duplex Black metal frame, M3 holes

Material:

1. Coupler Body: PC
2. Sleeve: Ceramic
3. Dust Cover: PE
4. Insert: ABS/PC
5. Frame: Black Nickel plated zinc diecast

Notes:

1. Insertion Loss: $\leq 0.3\text{dB}$