

NUT

WASHER

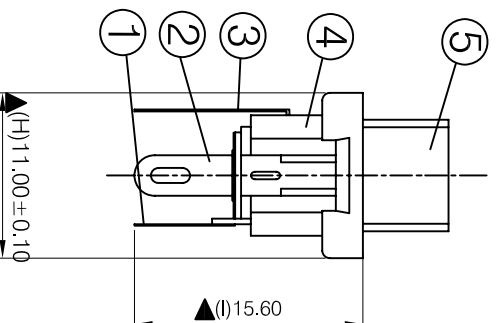
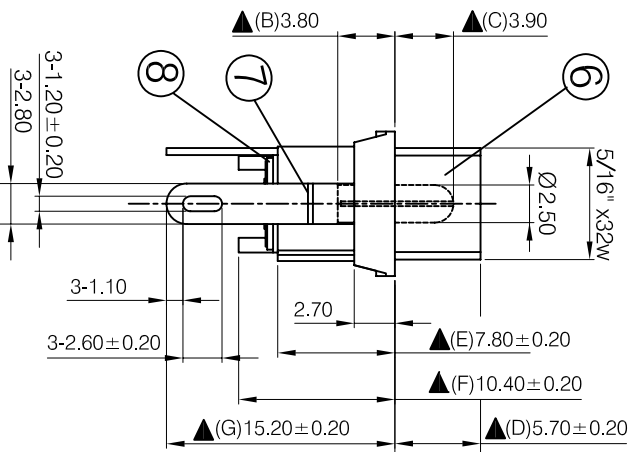

NO.	Description	Material	Q`TY	Finish
1.	Pin Terminal	0.3T Brass	1	Silver Plated
2.	Sleeve Spring	0.4T Phosphor Bronze	1	Silver Plated
3.	Break Terminal	0.3T Brass	1	Silver Plated
4.	Housing	PBT	1	Black Color
5.	Bushing	Brass	1	Nickel Plated
6.	Pin(2.5 Ø)	Copper	1	Nickel Plated
7.	Insulator A	Red Vulcanized Fibre	1	Red Color
8.	Insulator B	Red Vulcanized Fibre	1	Red Color
9.	Nut	2.1T Brass	1	Nickel Plated
10.	Washer	0.3T Steel	1	Nickel Plated

SPECIFICATIONS:

Contact Resistance : 30mΩ max
 Insulation Resistance : 100mΩ min. at DC 500V
 Dielectric Withstand Voltage : AC 500V for one minute
 Remark : ▲ : The Most Important Dimension

ROHS
COMPLIANT

Tolerance
 NO DEC. PLACE ±
 1 DEC. PLACE ±
 2 DEC. PLACE ±0.30
 DIA. HOLES ±
 ANGLES ± 1/2°
 UNLESS
 OTHERWISE STATED

WHERE USED F.R.

SCALE N.T.S.

DIMENSIONS IN MILLIMETERS UNLESS OTHERWISE STATED. WORK TO DIMENSIONS. DO NOT SCALE DRAWING. 3rd ANGLE PROJECTION. REMOVE BURRS. IF IN DOUBT ASK.

CLIFF

MATERIAL: COMPOSITE

FINISH: AS MOULDED

DRAWN: XHZ

TITLE: DC POWER JACK (2.5)

APPD : PCS

FORM:A4DRWGH

ISS	AMEND	DATE
1	1st DRAWN	11/03/09
2	WAS FC681446	30/07/09