

CLIFF

www.cliffcomponents.com

1/4" S1 Stack Jacks



S1 / S / BNB Special Nose



S1 / SHL / BBB Special Nose



S1 / SH / BBB with EMI / RFI Screen



EMI / RFI Screen



Colored Nuts



Slotted Ring Nut



Hex Chrome Nut

The **CLIFF**® range of S1 Stack Jacks incorporate significant new design features. The narrow-bodied design supports auto insertion and offers the highest board packing density available. Designed for snap-in PCB mounting to facilitate assembly and wave soldering, the S1 is available with chassis grounding and a choice of switching configurations, nose and mounting nut options.

Significant features include:

- Narrow body dual stacked versions offering the highest board packing density available.
- Snap-in PCB mounting to facilitate assembly and wave soldering.
- Optional chassis grounding versions.
- Body design supports auto-insertion.
- Choice of nose and fixing nut options.
- Patented Ni-Ag® Alloy Self-Cleaning Contacts for superior performance and reliability.

Cliff Electronic Components, Inc.
5610 S. Topeka Blvd., Suite C,
Topeka, KS 66609
Telephone: (785) 862-2543
Fax: (785) 862-5723
Email: sales@cliffusa.com

Cliff (Hong Kong) Limited
Room 1301, Seaview Commercial Building
21-24 Connaught Road West, Sheung Wan, Hong Kong
Telephone: (852) 2780 4576
Fax: (852) 2780 8535
Email: cliffhongkong@netvigator.com

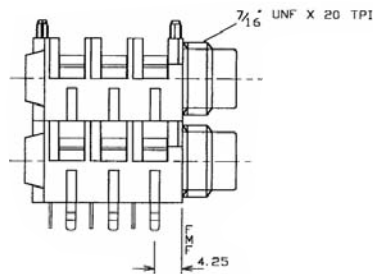

S1 / S

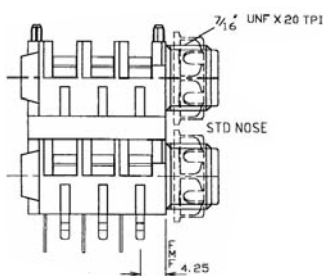
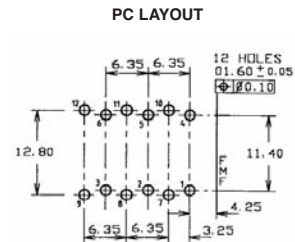
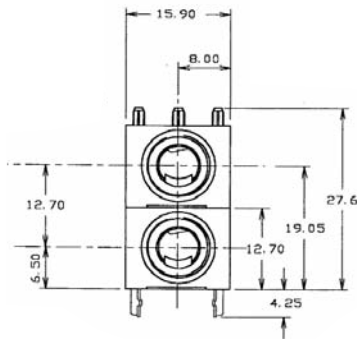

S1 / SHL

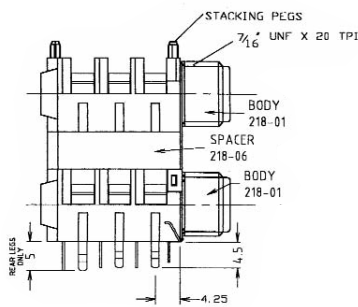
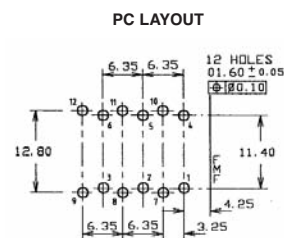
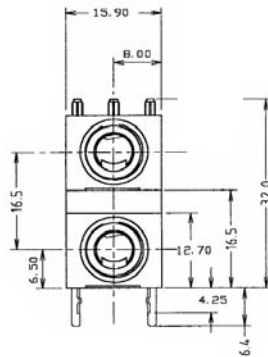

S1 / SH with EMI / RFI Screen

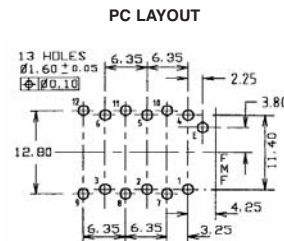
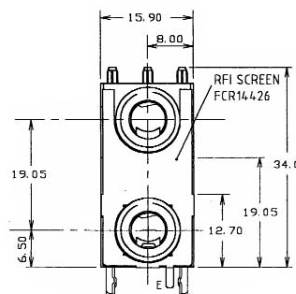

Technical Data: Withstand voltage: 2000V DC Min.
 Maximum Current: 5 amp.
 Temperature Rating: -10° C to + 70° C
 Life (Minimum): 10,000+ Operations. Cr <100mΩ
 Nominal Contact Resistance: <50mΩ

Specifications:

Designed to receive both mono and stereo 1/4" jack plugs, the S1 Stack Jack socket is molded in durable grade 1 black nylon with **CLIFF**® Ni-Ag® Alloy self-cleaning contacts for superior performance and reliability. Contacts can also be supplied with our special low noise Ni-Ag® 'ST' plating. The S1 is available with either a half or fully threaded nose and with a nylon nut (standard) or a nickel plated brass hexagonal or slotted ring nut. Mounting hardware, if required, is supplied unassembled. The S1 can also be supplied with prefitted EMI/RFI screen if required. When ordering, please state the contact arrangement required, with a plug inserted, using the following code from the front of the jack socket: B - Break, N - No Contact. For example, an S1/SH/BNB is a 2-pole stacked mono switched jack socket, 1st contact - Break, No 2nd contact and third contact - Break.